

Modeling of an Extraction Steam Turbine and Speed Control System Design

H.M. Abdullah^{1*}, G. Mustafa², K.S. Chaudri³ and M. Abid²

¹Management Information System Division, PINSTECH, Islamabad

²Department of Electrical Engineering, Pakistan Institute of Engineering & Applied Sciences (PIEAS) Islamabad, Pakistan

³Department of Nuclear Engineering, Pakistan Institute of Engineering & Applied Sciences (PIEAS) Islamabad, Pakistan

ABSTRACT

Steam-driven power plants essentially convert mechanical energy into electrical energy by using steam turbines. It is imperative to control the speed of the turbines as the frequency of the power system depends on it. This paper presents a model of a steam turbine containing three steam extractions from the intermediate-pressure section and four extractions from the low-pressure section. The underlying methodology for modeling is the continuity equation of a steam vessel. As the input variables, the model uses the valve opening degree of different valves, namely high-pressure valve, reheater valve, intermediate-pressure steam extraction valve and low-pressure steam extraction valve. The model behavior is observed against each input variable. It is then subsequently used to design the speed control system of the steam turbine using the proportional and proportional-integral controllers. The response of the speed control system is analyzed for both types of controllers and different valve openings. Simulation results demonstrate that the proposed model is suitable to study the dynamic behavior of an extraction steam turbine and for the feedback control system design.

Keywords: Steam turbine, Modeling, Speed control, Steam extractions

1. Introduction

Power plants using steam as the working fluid are major source of electricity. Over 80% of global electric power is being generated by steam-driven power plants. In steam-driven power plants, steam turbines are used as prime movers for electrical generators which then generate electrical energy [1]. Steam turbines are not only used in the power sector but also for industrial purposes. As the steam is allowed to expand through different blade stages of the turbine, the heat energy of superheated steam is converted into rotational mechanical energy. As a result, the turbine's rotor spins at a specific angular speed, which in turn drives the generator for the generation of electricity. It is, thus, crucial from the safety and performance perspective of the power plant that the speed of the turbine must be monitored and controlled to avoid any catastrophic situation and to improve the economics of the power plant.

For the model-based speed control system design of a turbine, we need its mathematical model which can depict the torque characteristics of the actual steam turbine with reasonable accuracy. Furthermore, transient operational behavior of steam turbines can be studied through simulations to face the challenges concerning efficiency, commissioning time, start-up time, operation, availability, safety, cost-effectiveness, etc. [2]. For this purpose, we can make use of the steam vessel transfer functions because the steam turbine is essentially a steam vessel where steam enters from one point and exits from another and expands in between them as reported previously [3].

A vast collection of steam turbine models is developed to

study their behavior and to analyze the stability of the speed control systems [3-5]. Most of these models are developed for non-extraction steam turbines and may not be suitable to represent steam turbine systems where extractions are employed from the turbine sections for feed-water (the water to be supplied to boiler from a tank or condenser for conversion into steam) heating or other heating purposes. Preheating the feed-water not only increases the efficiency of the plant but also improves the power plant cost economics. Complex turbines with multiple controlled and/or uncontrolled extractions are also popularly used in the process industry and cogeneration plants (plants which are used to generate electricity and useful heat at the same time) to provide steam of different temperature levels [6].

Some nonlinear models of steam turbines are also developed based on the energy balance, thermodynamic principles and semi-empirical equations [3-5, 7, 8]. Kulkowski et al. [9] presented simplified and detailed nonlinear models for Nuclear Power Plant (NPP) steam turbines, which included a static model and a dynamic model but without steam extractions. A non-extraction steam turbine model using hybrid-thermodynamic method and neural network approach has been presented by Dettori et al. [10] and Lu and Hogg [11] for online monitoring applications.

In this paper, a steam turbine model is presented exploiting a hybrid modeling approach to incorporate the effect of steam extractions in the turbine model, developed using the continuity equation. The mass continuity equation, as described previously [3], is employed to model the steam turbine cylinders, whereas the case study presented by Chaibakhsh and Ghaffari [7] is used for parametric estimation

*Corresponding author: abdullah-24@live.com

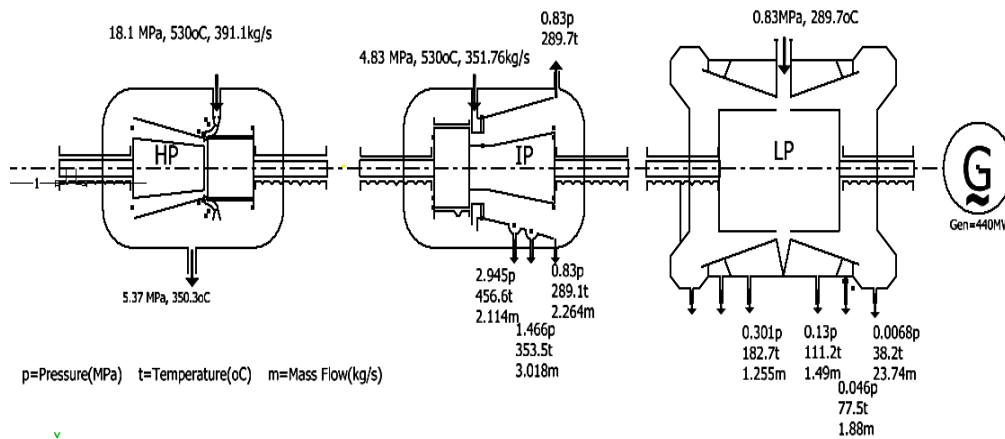

Fig. 1: Steam turbine configuration and steam conditions [6].

to include the steam extractions in analytical model of overall steam turbine system. The extractions from different turbine sections are modeled separately downstream their respective steam turbine sections. In a steam turbine system, multiple valves are employed to extract and control steam flow. Using this model, the effects of different valve openings are observed on the torque and speed characteristics. The developed model is then used to design a proportional (P) controller and a proportional-integral (PI) controller for the speed control of steam turbine. The response of the closed-loop speed control system is studied for different demands of the steam. Primarily, speed control is achieved by manipulating the High Pressure Valve (HPV) of the steam turbine, which controls the steam flow entering the High Pressure (HP) section of the steam turbine, and ReHeater Valve (RHV) that controls the flow of steam entering the Intermediate-Pressure (IP) and Low-Pressure (LP) turbine sections. A re-heater stores a large amount of steam; therefore, the HPV control alone is not enough to limit the over speed. The over-speed control involves fast control of the HPV and RHV because the RHV controls about 60% to 80% of the total power by controlling the steam flow to IP and LP sections of the steam turbine [5]. Simulation results depict the impact of steam extractions on the digital control algorithms which is identified as a research direction in future study.

2. System Description

Model simulations are an important tool in dynamic power systems. Most advanced control methods are based on process models [12]. This section describes an extraction steam turbine system for which a model is developed in the subsequent section.

2.1 Steam turbine system

Fig. 1 shows a typical steam turbine system representing the turbine configuration and thermodynamic steam properties at input/output and steam extractions. It represents a steam turbine of a 440 MW power plant with a once-through Benson type boiler. It comprises of HP, IP, LP sections and

also includes steam extractions, feed-water heaters, moisture separators and the related actuators.

The high pressure superheated steam acts as the working fluid and is responsible for energy flow. The superheated steam enters the HP turbine section at 530 °C and 18.1 MPa pressure, where it expands between turbine blade stages and energy conversion takes place. At the full load, the output temperature and pressure of steam from HP section are 350.3 °C and 5.37 MPa, respectively.

The discharged steam is passed through moisture separators to remove moist content. The cold steam is, then, sent to reheater where it is reheated to a temperature of 530 °C, at 4.83 MPa and is subsequently fed to IP turbine section. The exhaust steam from IP turbine is further expanded in LP section, whereas the input temperature and pressure of steam for LP turbine section are 289.7 °C and 0.83 MPa, respectively.

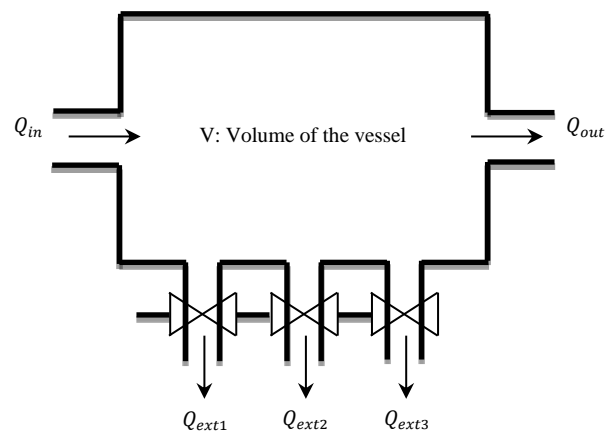

Fig. 2: A steam vessel with three steam extractions.

2.2 Assumptions

The following assumptions are made:

1. Extractions are treated as steam vessels.

2. Extraction flow rates are taken as a function of the inlet mass flow rate.
3. Controlled extractions are considered, i.e., steam is extracted through extraction valves. Furthermore, extractions of a particular turbine cylinder are controlled by its common extraction valve, e.g., the IP Extraction Valve (IPEV) and the LP extraction Valve (LPEV) as depicted in Fig. 2.
4. Leaks from valve stems and glands are not considered.

The steady-state flow rates, time constants and flow rate transfer functions are listed in Table1, where the symbol Q_{in} denotes the input steam flow rate.

3. Turbine Model Development

Different section of turbine system as shown in Fig. 1 are modeled in this section. As can be noticed that the HP section has no steam extractions. Whereas, IP and LP sections have three and four steam extractions from them, respectively. The steam extractions parameters and corresponding transfer functions are listed in Table 1.

Table 1: Steam extractions parameters and their transfer functions [7].

Turbine section	Extraction no.	Time constant	Steady state flow rate through extractions	Flow rate transfer function
IP	1	0.3	5.78% of Q_{in}	$\frac{0.0578}{0.3s + 1}$
	2	0.7	8.14% of Q_{in}	$\frac{0.0814}{0.7s + 1}$
	3	1.1	6.22% of Q_{in}	$\frac{0.0622}{1.1s + 1}$
LP	4	1.5	3.35% of Q_{in}	$\frac{0.0335}{1.5s + 1}$
	5	1.7	4.00% of Q_{in}	$\frac{0.04}{1.7s + 1}$
	6	1.9	5.11% of Q_{in}	$\frac{0.0511}{1.9s + 1}$
	7	2.1	67.36% of Q_{in}	$\frac{0.6736}{2.1s + 1}$

3.1 Modeling of HP section

The HP section of the steam turbine system does not include any steam extraction. Therefore, it can be modeled using the conventional way of steam vessel approach as reported in previous studies [1, 3-5].

$$\frac{Q_{out,HP}(s)}{Q_{in}(s)} = \frac{1}{0.25s + 1}$$

Whereas the power fraction for HP turbine is taken as:

$$F_{HP} = 0.3.$$

3.2 Modeling of the reheater

For a tandem-compound single-reheat turbine, the exhaust steam from HP section enters the reheater. A reheater has large mass storage and thermal capacity. It can be modeled as outlined previously [1, 3-5].

$$\frac{Q_{out,RH}(s)}{Q_{in}(s)} = \frac{1}{7.5s + 1}$$

3.3 Modeling of IP section with three steam extractions

The IP section has three extractions which are considered to be controlled by a single common IP extraction valve as depicted in Fig. 2.

Let W denotes the weight, V denotes the volume, ρ denotes the density, Q_{ext1} denotes the steam flow rate from extraction 1, Q_{ext2} denotes the steam flow rate from extraction 2, Q_{ext3} denotes the steam flow rate from extraction 3 and Q_{out} denotes the output steam flow rate of IP turbine section. Then, the continuity equation for this particular steam vessel is as follows:

$$\frac{dW}{dt} = V \cdot \frac{d\rho}{dt} = Q_{in}(t) - Q_{ext1}(t) - Q_{ext2}(t) - Q_{ext3}(t) - Q_{out,IP}(t)$$

or by using the chain rule,

$$V \frac{\partial \rho}{\partial P} \frac{dP}{dt} = Q_{in}(t) - Q_{ext1}(t) - Q_{ext2}(t) - Q_{ext3}(t) - Q_{out,IP}(t)$$

This continuity equation can also be written as:

$$T_v \frac{dQ_{out,IP}}{dt} = Q_{in}(t) - Q_{ext1}(t) - Q_{ext2}(t) - Q_{ext3}(t) - Q_{out,IP}(t)$$

Where, $T_v = V \cdot \frac{\partial \rho}{\partial P} \cdot \frac{P_0}{Q_0}$ denotes the time constant for the steam vessel, P_0 denotes the rated pressure of the vessel, and Q_0 denotes the rated flow of the vessel. Taking the Laplace transform and rearranging, the transfer function of the IP turbine with extractions can be written as:

$$\frac{Q_{out,IP}(s)}{Q_{in}(s)} = \frac{1}{T_v s + 1} - \frac{k_1}{T_{v_1} s + 1} - \frac{k_2}{T_{v_2} s + 1} - \frac{k_3}{T_{v_3} s + 1}$$

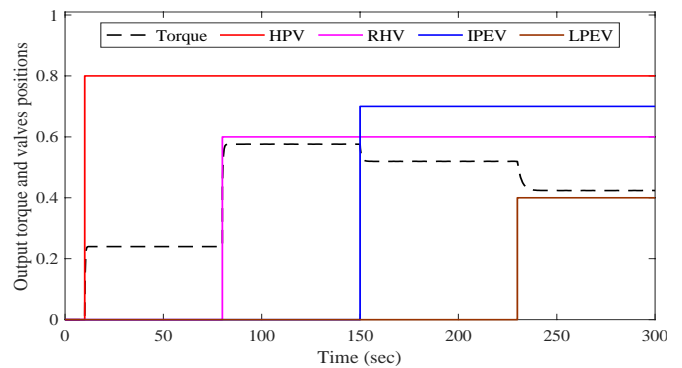

Fig. 3: Torque characteristics of turbine for different valve openings (%).

The time constant T_v for the IP turbine is negligible as the steam exits from reheaters with high pressure, therefore we can take $T_v = 0$. Putting the expressions for Q_{ext1} , Q_{ext2} and Q_{ext3} from Table1, we can get the transfer function of the IP turbine as:

$$\frac{Q_{out,IP}(s)}{Q_{in}(s)} = 1 - \frac{0.0578}{0.3s + 1} - \frac{0.0814}{0.7s + 1} - \frac{0.0622}{1.1s + 1}$$

$$F_{IP} = 0.4$$

3.4 Modeling of LP section with four steam extractions

For modeling of the low-pressure turbine section, the same assumptions have been made. Applying the continuity equation on LP turbine and using flow rate transfer function values for extractions from Table 1 and following the modeling procedure similar to IP turbine we can drive the transfer function model for the LP Turbine section as follow:

$$\frac{Q_{out,LP}(s)}{Q_{in}(s)} = \frac{1}{0.4s + 1} - \frac{0.0335}{1.5s + 1} - \frac{0.04}{1.7s + 1} - \frac{0.0511}{1.9s + 1} - \frac{0.6736}{2.1s + 1}$$

3.5 Overall turbine system model

The overall turbine model comprises of the HP, IP, and LP turbine sections. It also includes a model of the reheater valve. The sum of the power fractions of the various turbine sections is given as follow [3-5].

$$F_{HP} + F_{IP} + F_{LP} = 1$$

The inputs to the model are valve positions of different valves. The output of the model is the mechanical power.

3.6 Torque characteristics of turbine model

Torque characteristics of extraction steam turbine are shown in Fig. 3, when different steam valves are opened at different times. The output torque and different valve openings are shown in percentages. When HPV is opened to 80% at T = 10 seconds, the torque starts to develop in the HP steam turbine and attains a steady value of 24%. As only HPV is opened and RHV is kept closed, so for this particular condition no steam is passed through the RHV. Upon opening RHV to 60% at T = 80 seconds, the torque increases further and settles at the steady-state value of about 57%.

When the IP extraction and the LP extraction valves are opened at T = 150 seconds and T = 230 seconds, respectively, the torque is reduced. From Fig. 1, it can be observed that when IP and LP extraction valves are opened, steam will be extracted from turbine cylinders. This will result in the

decrease of mechanical power developed in the shaft of the steam turbine. Also, from Table 1, it can be noted that for 70% opening of the IP extraction valve, about 14% of the total flow rate is extracted by the IP turbine section. Whereas, a 40% opening of the LP extraction steam valve implies that about 32% of Q_{in} is extracted by the LP turbine section.

4. Speed Control System Design for Steam Turbine

For safe and reliable operation of steam turbines, multiple protection and control systems are employed, collectively termed as Turbine Supervisory Instrumentation (TSI) [13]. TSI detects and measures the deviation from operating conditions and malfunctions. Whereas, control systems are designed to control various parameters of the steam turbine for its safe operation. The model of a system used for control purposes needs to be as simple as possible, as its simplicity will ensure small computational complexity [14-16].

Speed is an important parameter of a steam turbine to be controlled which is primarily controlled by the governor valves. Various control mechanisms are in use to drive the governor valve. We have used the mechanical-hydraulic mechanism as it is a common mechanism used for speed control. Speed relays and servomotors are taken as a mean of speed governor system. A block diagram for the speed control system, driving mechanism and turbine system is shown in Fig. 4. This control system is subjected to different types of control techniques and load demands to analyze the control system performance. Fig. 5 to Fig. 9 show speed characteristics for different valve openings. Speed and valve positions are taken in percentage, i.e., 0 represents no speed (or a fully closed valve) whereas 1 indicates full speed (or a fully opened valve).

4.1 Speed control with a proportional control

For the proportional control (P-controller), the proportional gain is tuned to 5.5. Fig. 5 shows the speed variations when the speed changer position is changed. In this scenario RHV, IP and LP extraction valves are kept closed; however, speed reference is changed. The speed reference is changed twice, first at T = 0 second and then at T = 70 seconds. The control system successfully attains the desired speed and no overshoot is observed.

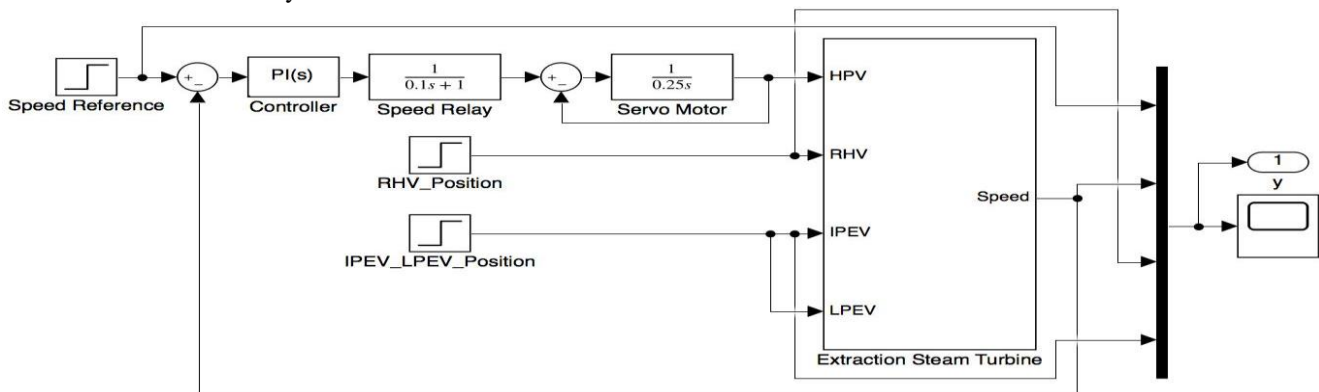

Fig. 4: Block diagram of speed control system of steam turbine.

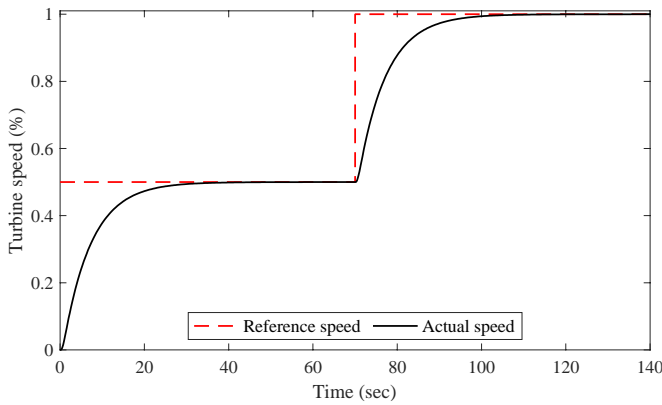

Fig. 5: Turbine speed response with a P-controller to a step change in reference speed.

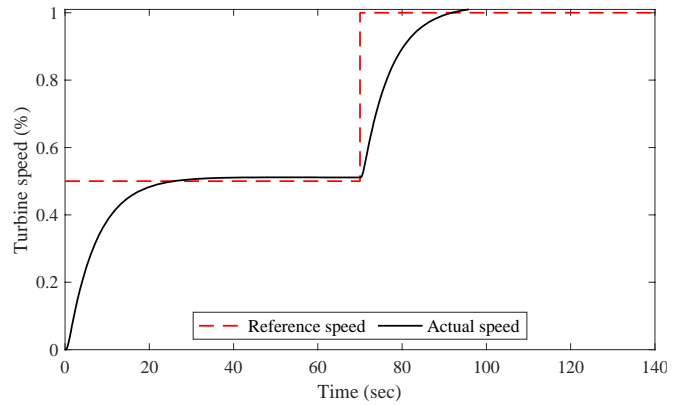

Fig. 7: Turbine speed response to a step change in reference speed with a PI-controller.

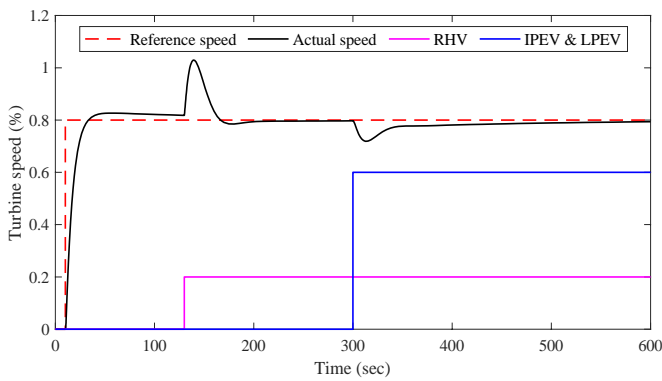

Fig. 6: Turbine speed response with a P-controller to a step change in reference speed and different valves openings.

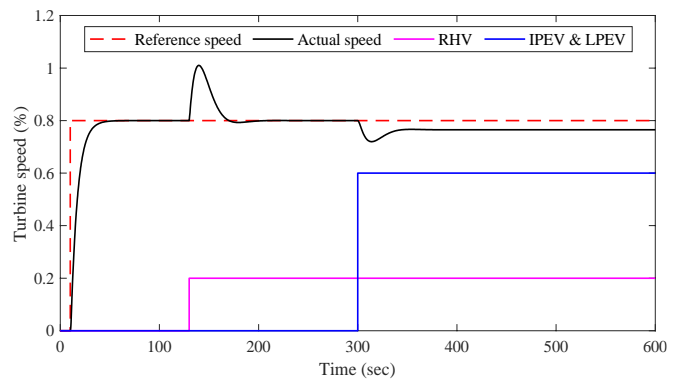

Fig. 8: Turbine speed response to a step change in reference speed and different valves opening with a PI-controller.

Fig. 6 shows the speed characteristics of proportional control when speed reference, RHV, and extraction valves are opened at different time instants. In this case, when the speed reference is set to 100% at $T = 10$ seconds, the turbine rotor speeds up with no overshoot. However, when RHV is opened at $T = 130$ seconds, the control system exhibits an overshoot of about 20%. P-controller compensates for this overshoot by limiting the inlet steam flow rate. Furthermore, the opening of extraction valves causes the speed to drop by 8%. The P-controller compensates for this decrease in speed by opening the HPV valve and consequently, the speed is maintained with a steady-state error of about 3.5%.

4.2 Speed control with proportional and integral control

Simulation results for proportional-integral control (PI-controller) are shown in Fig. 7 and Fig. 8. The PI-controller parameters are tuned to be, $K_P = 5.5$ and $K_I = 0.02$.

Here, again the control system is subjected to different scenarios. Fig. 7 shows the response when the speed changer position is changed. Fig. 8 shows the situation when different valves are opened at different time instants. When the speed reference is changed at $T = 10$ seconds, the control system achieves the desired speed. Then, the opening of RHV results in an overshoot of around 20% in the turbine's speed. Whereas, opening of IP and LP extraction valves to 60% causes a drop of around 8%. The PI-controller compensates for this disturbance by manipulating the high pressure valve

correspondingly. The steady-state error is observed to be 0 for PI-controller.

Fig. 9 shows the performance comparison of P and PI-controllers. At the instant when RHV is opened, both controllers exhibit an overshoot of about 20%. The steady-state error is zero for PI-controller, but P-controller shows a steady-state error of 3.5%.

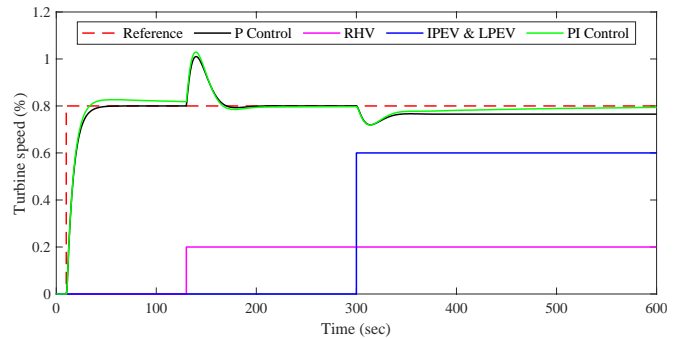

Fig. 9: Comparison of turbine speed responses with P and PI-controllers.

5. Conclusions

Steam turbine modeling and speed control system design is difficult because it is part of a complex interconnected system. Most practical steam turbines at generation plants comprise of steam extractions to increase the overall plant efficiency. The dynamic response of a steam turbine can be

related in terms of changes in steam valves opening (HPV position and RHV position) and also the steam extraction valves openings.

In this paper, based on the continuity equation for steam vessel and steam turbine empirical relations, a model of an extraction steam turbine comprising HP, IP and LP turbine sections is developed. This model is then used for the speed controller design for the steam turbine. A steam turbine's speed response depends on several factors, e.g., RHV position, HPV position, speed reference change and extraction valves positions. However, good speed stability can be achieved by a suitable controller design.

References

- [1] M. Bennauer, E.G. Egener, R. Schlehuber, H. Werthes and G. Zimmer, "Automation and control of electric power generation and distribution system: Steam turbines", *Control Syst. Robot. Autom.*, vol. 18, pp. 261-271, 2009.
- [2] G. Zimmer, "Modelling and simulation of steam turbine processes: Individual models for individual tasks", *Math. Comp. Model. Dyn. Syst.*, vol. 14, pp. 469-493, 2008.
- [3] R.T. Byerly, O. Aanstad, D.H. Berry, R.D. Dunlop, D.N. Ewart, B.M. Fox, L.H. Johnson and D.W. Tschappat, "Dynamic models for steam and hydro turbines in power system studies", *IEEE Trans. Pow. App. Syst.*, vol. 6, pp. 1904-1915, 1973.
- [4] M. Dulau and D. Bica, "Mathematical modelling and simulation of the behaviour of the steam turbine", *Procedia Technol.*, vol. 12, pp. 723-729, 2014.
- [5] M. Dulau and D. Bica, "Simulation of speed steam turbine control system", *Procedia Technol.*, vol. 12, pp. 716 - 722, 2014.
- [6] X. Luo, B. Zhang, Y. Chen and S.P. Mo, "Modeling and optimization of a utility system containing multiple extractions steam turbines", *Energy*, vol. 36, pp. 3501-3512, 2011.
- [7] A. Chaibakhsh and A. Ghaffari, "Steam turbine model", *Simul. Model. Pract. Theor.*, vol. 16, pp. 1145-1162, 2008.
- [8] H. Rusinowski and M. Plis, "Mathematical model of a steam turbine for the thermal diagnostics system", *Proc. Int. Carpath. Ctrl. Conf. (ICCC)*, Tatranska Lomnica, Slovakia, pp. 630-634, 2016.
- [9] K. Kulkowski, M. Grochowski, K. Duzinkiewicz and A. Kobylarz, "Nuclear power plant steam turbine: Modeling for model based control purposes", *Appl. Math. Model.*, vol. 48, pp. 491-515, 2017.
- [10] S. Dettori, V. Colla, G. Salerno and A. Signorini, "Steam turbine models for monitoring purposes", *Energy Procedia*, vol. 105, pp. 524-529, 2017.
- [11] S. Lu and B.W. Hogg, "Dynamic non-linear modeling of power plant by physical principles and neural networks", *Int. J. Elect. Pow. Energy Syst.*, vol. 22, pp. 67-78, 2000.
- [12] E.J. Farmer and B.G. Liptak, *Process Control and Optimization: Steam turbine controls*, 4th ed., vol. 2, Washington D.C., CRC Press, pp. 2137-2151, 2006.
- [13] W. Aleite, K. Ara, J. Berggren, A. Faya and C.G. Forstner, "Modern Instrum. and Control for Nuclear Power Plants: A guidebook", International Atomic Energy Agency (IAEA), Vienna, Technical Reports Series, no. 387, 1999.
- [14] K. Kulkowski, A. Kobylarz, M. Grochowski and K. Duzinkiewicz, "Dynamic model of nuclear power plant steam turbine", *Archive Control Sci.*, vol. 25, pp. 65-86, 2015.
- [15] B. Vahidi, M.R.B. Tavakoli and W. Gawlik, "Determining parameters of turbine's model using heat balance data of steam power unit for educational purposes", *IEEE Trans. Pow. Syst.*, vol. 22, pp. 1547-1553, 2007.
- [16] R. Rajan, P.M. Salih and N.A. Kumar, "Speed controller design for steam turbine", *Int. J. Adv. Res. Electr. Electron. Instrum. Eng.*, vol. 2, pp. 4400-4409, 2013.